

**MET 164 X**



**MEC 165 X**



**MEC 62 X**



**MEC 62 W**

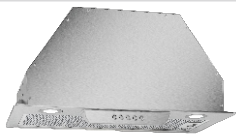

**MEE 52 X**

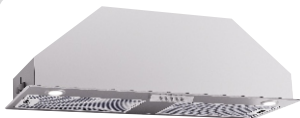

**MEE 82 X**



# CLASSIC COOKER HOOD

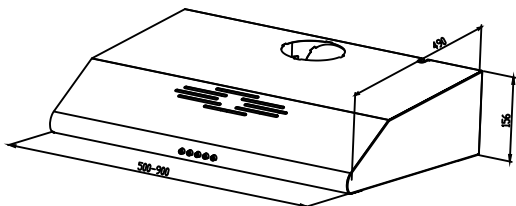

# BUILT-IN HOOD

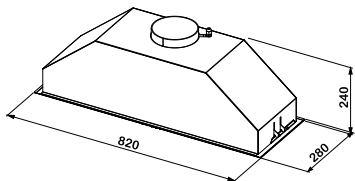
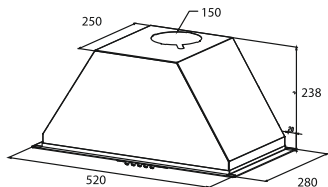
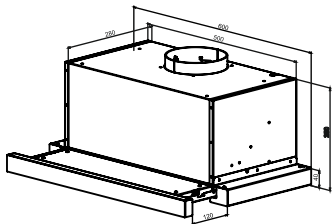
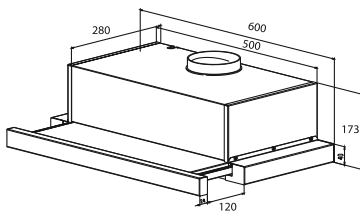

## SAFETY AND SECURITY INSTRUCTIONS

Read the safety and security instructions carefully and keep for future reference.

- . This appliance can be used by children aged 8 years and above and persons with reduced physical, sensory or mental capabilities or lack of experience and knowledge, if they have been given supervision or instruction concerning use of the appliance in a safe way and understand the hazards involved.
- . This product is designed for domestic use and is not suitable for commercial use.
- . Run the product in accordance with the intended use described in this manual.
- . The operating voltage of your product is 220 - 230 Volt~50 Hz.
- . During assembly, the feeder cable of the device should not be exposed to being squeezed or crushed. Feed cable should not pass near the stoves. Such situations can cause a fire.
- . Do not insert the plug into the socket before the product is installed.
- . Run the product after you put pot, pan etc on the stove. Otherwise, high temperature may cause damage to some parts of the product.
- . Turn off the stove before taking the pot, pan etc. from the stove.
- . Wash the oil filters at least once a month. Change the carbon filters every 3 months.
- . Flammable food must not be cooked under the product.
- . In order to cut off the electricity of the product in case of any danger, make sure that the socket where the plug is plugged into is easily accessible.
- . Do not operate your product without a filter, do not remove the filters while the product is running.
- . Use only original parts or parts recommended by the manufacturer.
- . Follow the rules and guidelines of the competent authorities regarding the discharge of the exit air. (This warning is not valid for use without flue.)
- . When you make a flue connection to your product, use pipes with a diameter of 150 mm or 120 mm. The pipe connection should be as short as possible and with few bends.
- . For your safety, use "MAX 6 A" fuse in the installation.
- . In the environment where the product will be used, the exhaust of this device, which runs with fuel oil or gaseous fuels, such as room heater, must be completely isolated from the volume where it is located.
- . Keep all packaging materials away from children.
- . When the installation of the product is completed, there must be a distance of at least 65 cm between the product and electric stoves, and at least 75 cm between stoves running with gas or other fuels.

### **Compliance with WEEE Regulation and Disposal of Waste Product**

This product does not contain harmful and banned substances specified in "Waste Electrical and Electronic Equipment Control Regulation" published by T.R. Ministry of Environment and Urbanisation.



This device complies with WEEE Regulation. This product is manufactured from high quality parts and materials that can be recycled and reused. Therefore, do not dispose of the product with household or other waste at the end of its service life.

## Compliance with WEEE Regulation and Disposal of Waste Product

This product does not contain harmful and banned substances specified in "Waste Electrical and Electronic Equipment Control Regulation" published by T.R. Ministry of Environment and Urbanisation.



This device complies with WEEE Regulation. This product is manufactured from high quality parts and materials that can be recycled and reused. Therefore, do not dispose of the product with household or other waste at the end of its service life.

## OPERATION MODES – USE WITHOUT FLUE CONNECTION

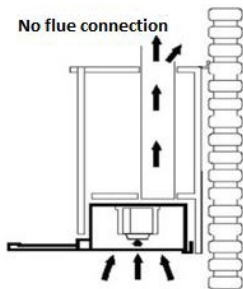

The sucked air is cleaned by passing through the grease filter and an activated carbon filter and returned to the kitchen. Carbon filters are used when it is not possible to have a chimney in the house.

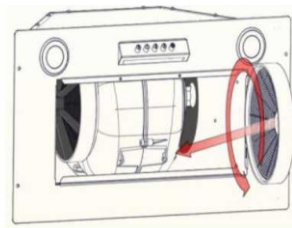
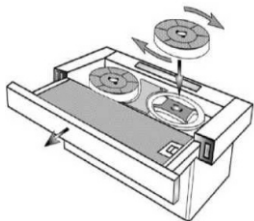

Round carbon filters are attached to the tabs on the engine cover of the product by turning them clockwise. In terms of usage and performance, it is recommended to replace the carbon filters every 3 months. Carbon filters are not washable.



## CHANGE OF LAMP

While changing the bulb, cut off the electrical connection of your product. While the lamps are hot, it may burn your hand, wait for it to cool down.



### Candle Bulb

For change of candle bulb, remove the aluminum cassette filter. Remove the faulty bulb and replace it with a new bulb of the same value.

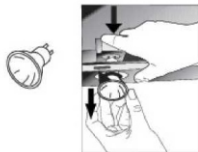

### Round Led Spot

There are two types of round led spotlights, with and without spring. In order to remove the spring-loaded round spot, it will be sufficient to pull the spot downwards by pressing the springs upwards. In order to remove the springless spot, it will be sufficient to pull the spot downwards by pressing the plastic tabs around the spot.

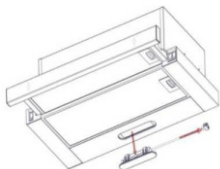

### Oval Led Lamp

To remove the oval led lamp, first remove the aluminum cassette filter at the back. It can be displaced by pressing the tabs on the back of the oval lamp.

## PROBLEMS VE SOLUTIONS

	Control the electrical contact. (Grid voltage must be 220V)	Control the engine switch. (Engine switch must be in open position)	Control the lamb switch. (Lamb switch must be in open position)	Control the aluminium filter. (Aluminium cassette filter must be washed once a month normally.)	Control the lambs. (The lambs must be intact.)	Control the air discharge flue. (The air discharge flue must be open.)	Check the carbon filter. (For the ones working with carbon filters) (Carbon filters must be changed once in 3 months normally.)
Aspirator is Not Working	X	X					
Lighting Lamb is Not Working	X		X		X		
Aspirator's Traction is Weak				X		X	X

## INSTALLATION OF THE DEVICE

Before starting the installation, read the safety information in the user manual

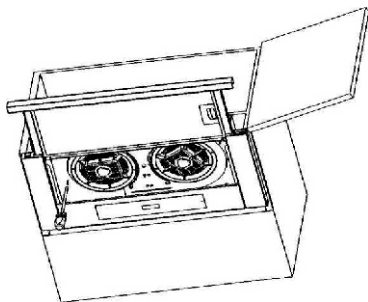

For the sliding aspirator assembly, drill a  $\varnothing 4$  mm drill hole into the wood at the points corresponding to the mounting holes. Mount the product from four (4) points using the mounting screws given with the device.

### Sliding Aspirator Assembly Schema

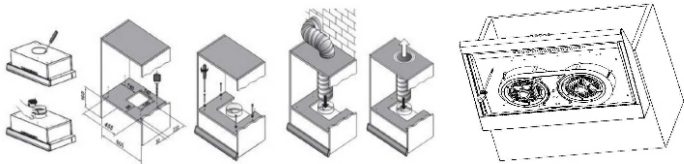

For standard aspirator assembly, drill a  $\varnothing 4$  mm drill hole into the wood at the points corresponding to the mounting holes. Mount the product from four (4) points using the mounting screws given with the device.

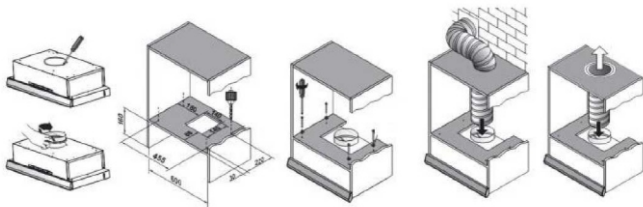

After placing the plastic flue at the motor output, attach the flexible aluminum pipe to the plastic flue. Plug the other end of the pipe into the flue hole in the wall. Example image is as follows.

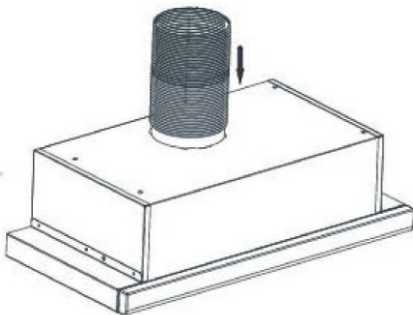

When the slide set moves, the front panel should not rub against the cabinet door. A suitable air outlet pipe should be connected to the air outlet of the aspirator in the part inside the cabinet. In cases where the flue connection pipe must be long, the use of a smooth inner surface pipe will preserve the air suction performance of the product.

**NOTE:** It is up to the customer to provide the air outlet pipe and clamp.

## GD52 Model Assembly Schema

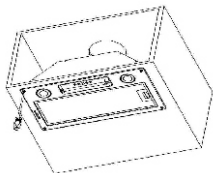

For a fully built-in aspirator assembly, drill a  $\varnothing 4$  mm drill hole into the wood at the points corresponding to the mounting holes. Mount the product from four (4) points using the mounting screws given with the device.



For screwless assembly of the fully built-in aspirator, two tension pegs (hidden mounting apparatus) on the sides of the aspirator are placed on the wood, then screwed with the help of a screwdriver as shown in the figure and the assembly process is carried out.

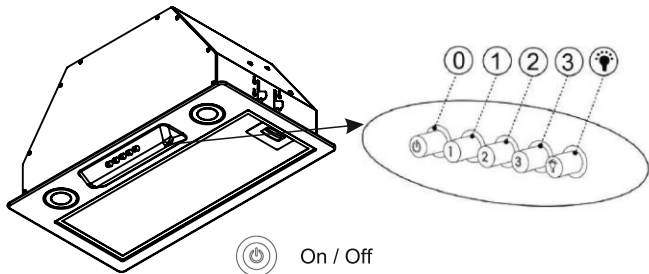

On / Off



Motor runs on Level 1



Motor runs on Level 2



Motor runs on Level 3



Lamp On / Off

## GD82 Model Assembly Schema

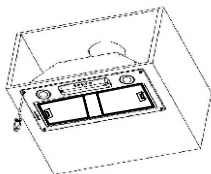

For a fully built-in aspirator assembly, drill a  $\varnothing 4$  mm drill hole into the wood at the points corresponding to the mounting holes. Mount the product from four (4) points using the mounting screws given with the device.

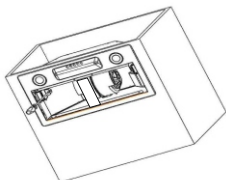

For screwless assembly of the fully built-in aspirator, two tension pegs (hidden mounting apparatus) on the sides of the aspirator are placed on the wood, then screwed with the help of a screwdriver as shown in the figure and the assembly process is carried out.

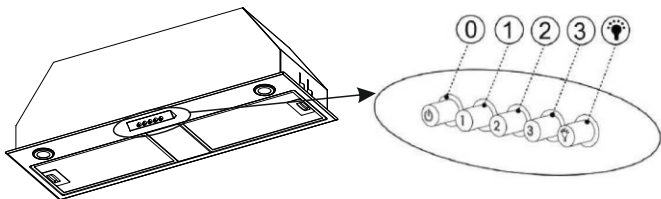

On / Off



Motor runs on Level 1



Motor runs on Level 2



Motor runs on Level 3



Lamp On / Off

## USE OF THE DEVICE

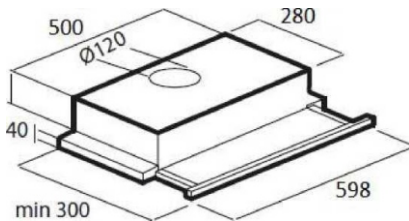

max 457

1) Galvanized Body

2) Decorative Front Panel

3) Lightning Switch

4) Aluminium Oil Filter

5) Moving Slide Mechanism

6) Control Switch

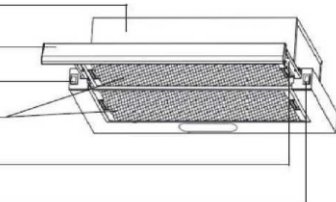

The lamp is on the left when the slide is pulled. The engine control switch is on the right when the slide is pulled.

. Switch A: Lighting control

. Switch B: 1st and 2nd speed control

. Key C: 3rd speed control

The switch of the fan motor ( B and C ) has 3 stages. You can turn the lighting lamp of your aspirator on and off using the A switch.



A



B



C

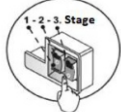
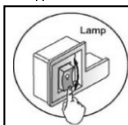
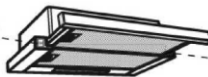

### 1 Lighting

Light On / Off

### 2 Fans

0 Fan Off

1 Fan level 1

2 Fan level 2

3 Fan level 3

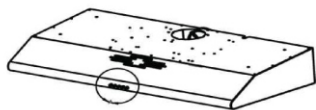

On / Off



Motor runs on Level 1



Motor runs on Level 2



Motor runs on Level 3



Lamp On / Off

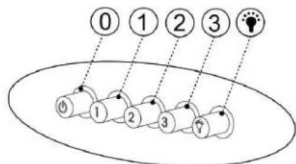

### USE WITH CARBON FILTER AND FRONT BLOWING MECHANISM

If there is no flue connection for exhaust in the kitchen, the use of carbon filters is mandatory. In standard aspirators, front blowing mechanism is activated when carbon filter is used.

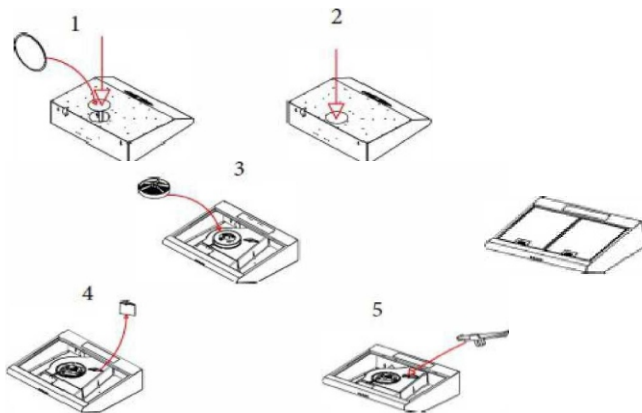

The back part of the product is closed by placing the flue outlet closure plastic, which is given in the image number 1, from the assembly bag given with the product, on the tabs on the product. The relevant carbon filter is attached to the engine cover by turning it clockwise as indicated in the image number 3. The plastic part indicated in the image number 4 is removed from its place and the small plastic piece indicated in the image number 5 and included in the assembly bag is screwed into the place of the removed plastic piece in the number 4. In this way, the product becomes ready for use with a carbon filter and front blowing.

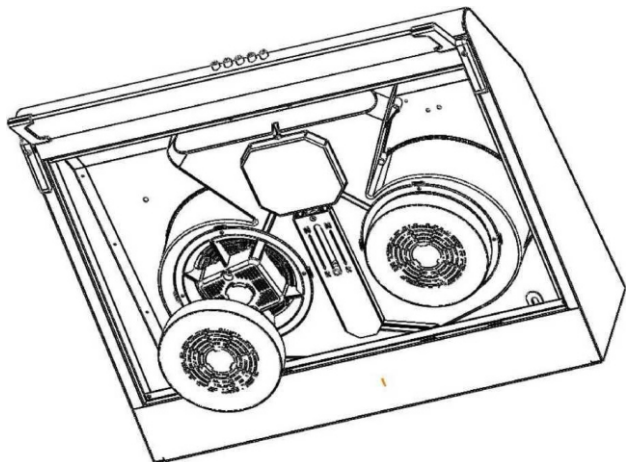

To use the standard aspirator with double motor as front blowing, the slide of the plastic container is pulled towards the letter R, and the round carbon filters shown on the product are attached. Flue outlet closure plastic is attached to the flue outlet part of the product and the product becomes ready for use with a carbon filter.

**If you need shipping;**

- . If possible, carry it in its original box.
- . If the sliding aspirator does not have its original box, tape it to the body to prevent the sliding panel from moving during transportation.
- . Take precautions against possible impacts to your product.
- . Keep your product in its normal position during transportation.